



AMERICAN FLOOR PRODUCTS COMPANY, INC.

AFco-USA

P.O. BOX 7055 • Gaithersburg, Maryland 20898 -7055 • 301-987-0490 • Fax 301-987-0422
email: sales@afco-usa.com • Web Site: www.afco-usa.com

CUSTOMER P.O. #

LAMINATED DOCK BUMPER® (LB-2240)

Style B410-24

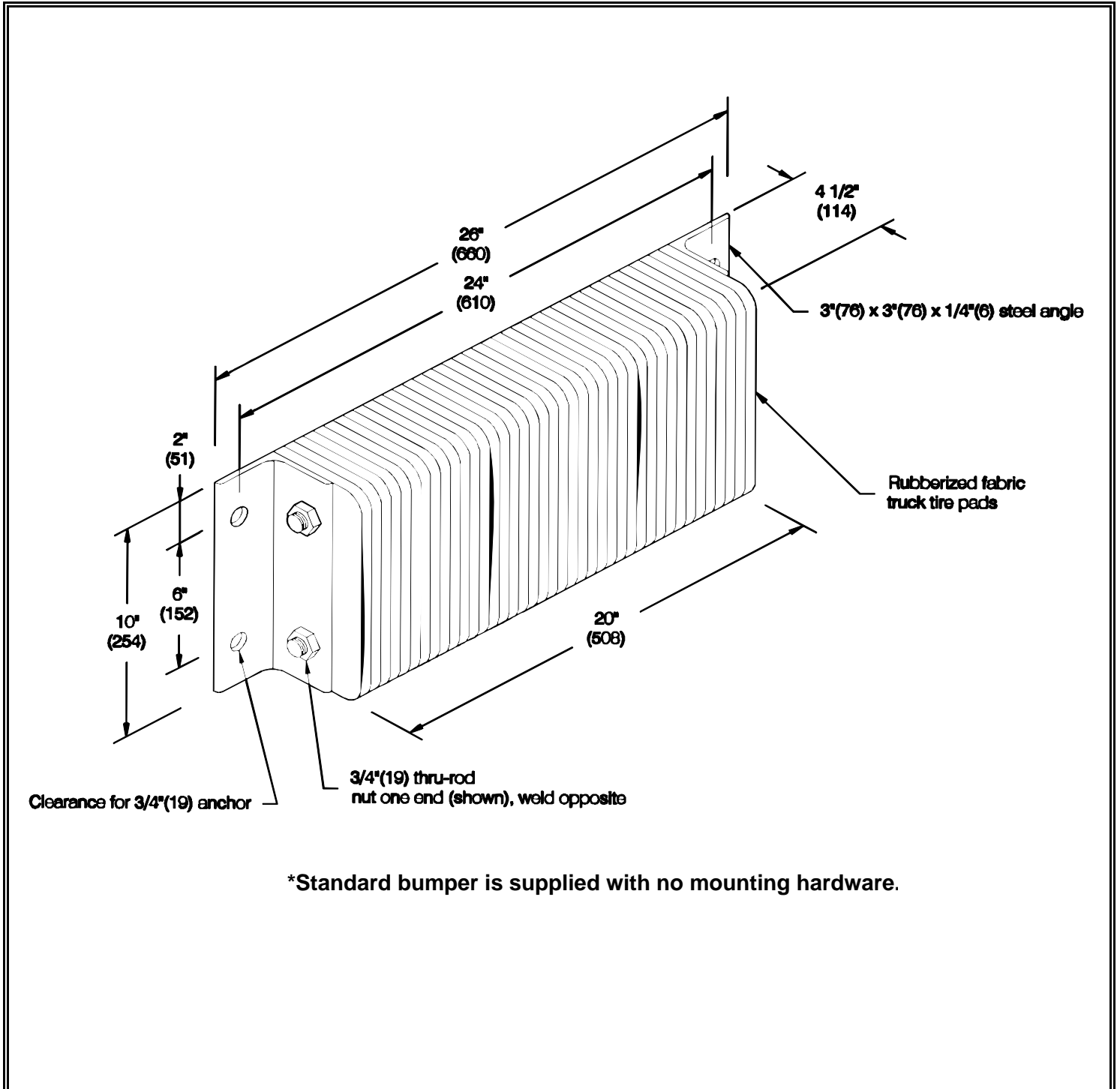

*Standard bumper is supplied with no mounting hardware.

LAMINATED DOCK BUMPER® (LB-2240)

Style B410-24

Profile	Application	Shock absorbing	Materials	Flammability & smoke developed (ASTM E-84)
Laminated	High abuse	80%	Recycled truck tires Metal components	N/A

<p>Features:</p> <ul style="list-style-type: none"> • Horizontal mounting • Weight: 46 lbs. • Attractive deep black color enhances a professional architectural look • Manufactured under pressure exceeding 1,500 lbs. (680.40 kg) to absorb over 80% of impact. <p>Applications:</p> <ul style="list-style-type: none"> • High traffic commercial loading docks • Rub rails along sides of truck wells • Industrial plant wall protection 	<p>Finishes (metal components):</p> <ul style="list-style-type: none"> • Specify: Chrome aluminum lead-free enamel #107 or hot-dip galvanized #108 <p>Suggested Mounting Hardware:</p> <ul style="list-style-type: none"> • Wedge anchor series: Expansion anchor - for use in pre-drilled holes on existing concrete walls. • J-Bolt series: Cast-in-place anchor - for use in new concrete wall construction
--	---

Bumper designs conform to OSHA, ANSI Life Safety, NFPA, BOCA, UBC, BOMA, ICBO, SBCCI, American Disabilities Act Accessibility Guidelines and all National Building /Code requirements.

JOB NAME:	ITEMS	QUANTITY
JOB NUMBER:	Dock Bumper:	
CONTRACTOR:	Galvanized:	Yes <input type="checkbox"/> No <input type="checkbox"/>
ARCHITECT:	Bolt Type:	
DEALER NAME:		
SIGNATURE:	Date:	